



Air Conditioners

# Technical Data

Wall mounted unit



EEDEN12-100

FTXG-JA

# TABLE OF CONTENTS

## FTXG-JA

1	Features .....	2
2	Specifications .....	3
	Technical Specifications .....	3
	Electrical Specifications .....	4
3	Options .....	5
	Options .....	5
4	Dimensional drawings .....	6
	Dimensional Drawings .....	6
5	Centre of gravity .....	7
	Centre of Gravity .....	7
6	Piping diagrams .....	8
	Piping Diagrams .....	8
7	Wiring diagrams .....	9
	Wiring Diagrams - Single Phase .....	9
8	Sound data .....	10
	Sound Pressure Spectrum .....	10

# 1 Features

- 24 hour timer can be set to start heating or cooling anytime during a 24 hour period
- Remarkable blend of iconic design and engineering excellence with an elegant finish in brushed aluminium or matt crystal white
- Weekly timer can be set to start heating or cooling anytime on a daily or weekly basis
- The infrared remote control is user friendly and equipped with a timer function that enables you to programme the unit to start or stop at your desired time.
- Comfort mode guarantees draught free operation by preventing that warm or cold air is directly blown on to the body
- Indoor unit silent operation: "silent" button on the remote control lowers the operation sound of the indoor unit by 3dBA
- Movement sensor saves power consumption in unoccupied rooms: when the room is empty, the unit switches to economy mode after 20 minutes and restarts when a person enters the room.
- Night set mode saves energy by preventing overcooling or overheating during night time
- Powerful mode can be selected for rapid heating or cooling; after the powerful mode is turned off, the unit returns to the preset mode.
- Titanium apatite photocatalytic air purification filter removes airborne microscopic particles, powerfully decomposes odours and helps to prevent the propagation of bacteria, viruses, microbes to ensure a steady supply of clean air



## 2 Specifications

2-1 Technical Specifications				FTXG25JV1BA	FTXG35JV1BA	FTXG50JV1BA	
Power input	Cooling	Nom.	kW	0.018 (3) / 0.018 (4) / 0.018 (5)	0.026 (3) / 0.026 (4) / 0.026 (5)	0.032 (3) / 0.032 (4) / 0.032 (5)	
	Heating	Nom.	kW	0.024 (3) / 0.024 (4) / 0.024 (5)	0.032 (3) / 0.032 (4) / 0.032 (5)	0.038 (3) / 0.038 (4) / 0.038 (5)	
Casing	Colour			Brushed aluminium			
Dimensions	Unit	Height/Width/Depth	mm	295/915/155			
	Packed unit	Height/Width/Depth	mm	377/1,003/285			
Weight	Unit			kg			
	Packed unit			kg			
Packing	Weight			kg			
Heat exchanger	Length			mm			
	Rows	Quantity					
	Fin pitch			mm			
	Stages	Quantity					
	Tube type				ø6.35 HI-XD tube		ø6.35 HI-XU tube
	Fin	Type		Multi slit fin			
Fan	Type			Cross flow fan			
	Air flow rate	Cooling	High	m³/min	8.8	10.1	10.3
				cfm	311	375	364
			Nom.	m³/min	6.8	7.3	8.5
				cfm	240	258	300
			Low	m³/min	4.7	4.6	6.7
				cfm	166	162	237
		Silent operation	m³/min	3.8	3.9	5.7	
			cfm	134	138	201	
		Heating	High	m³/min	9.6	10.8	11.4
				cfm	339	381	402
			Nom.	m³/min	7.9	8.6	9.8
				cfm	279	304	346
	Low		m³/min	6.2	6.4	8.1	
			cfm	219	226	286	
	Silent operation	m³/min	5.4	5.6	7.1		
cfm		191	198	251			
Fan motor	Model			KFD-280-40-8G			
	Speed	Steps		5 + silent, + auto			
		Cooling	High/Medium/Low/Silent operation	rpm	1,440/1,170/900/780	1,640/1,270/910/810	1,710/1,470/1,230/1,100
	Heating	High/Medium/Low/Silent operation	rpm	1,560/1,330/1,110/1,000	1,720/1,430/1,140/1,030	1,830/1,610/1,390/1,260	
Output	High	W		29		40	
Sound power level	Cooling	High	dBA	54	58	60	
	Heating	High	dBA	55	58	60	
Sound pressure level	Cooling	High/Nom./Low/Silent operation	dBA	38/32/25/22	42/34/26/23	44/40/35/32	
	Heating	Super high/High/Nom./Low/Silent operation	dBA	-/39/34/28/25	-/42/36/29/26	-/44/40/35/32	
Refrigerant	Type			R-410A			
Piping connections	Liquid	OD	6.35				
	Gas	OD	9.52		12.7		
	Drain			16 or 18		18	
	Heat insulation			Both liquid and gas pipes			
Temperature control	Microcomputer control						
Air direction control	Right, Left, Horizontal, Downward						
Air filter	Removable / washable / mildew proof						

Standard Accessories : Paper pattern: Quantity : 2;

Standard Accessories : Mounting plate; Quantity : 1;

Standard Accessories : Indoor unit fixing screws; Quantity : 2;

Standard Accessories : Remote control holder; Quantity : 1;

Standard Accessories : Batteries; Quantity : 2;

Standard Accessories : Wireless remote control; Quantity : 1;

Standard Accessories : Installation manual; Quantity : 1;

## 2 Specifications

Standard Accessories : Operation manual; Quantity : 1;

Standard Accessories : Titanium apatite photocatalytic air purification filter; Quantity : 2;

2-2 Electrical Specifications				FTXG25JV1BA	FTXG35JV1BA	FTXG50JV1BA
Power supply	Name			V1		
	Phase			1~		
	Frequency		Hz	50		
	Voltage			220-230-240		
Current	Nominal running current (RLA) - 50Hz	Cooling	A	0.09 (3) / 0.08 (4) / 0.08 (5)	0.13 (3) / 0.12 (4) / 0.12 (5)	0.16 (3) / 0.15 (4) / 0.14 (5)
		Heating	A	0.12 (3) / 0.11 (4) / 0.11 (5)	0.16 (3) / 0.15 (4) / 0.14 (5)	0.19 (3) / 0.18 (4) / 0.17 (5)
Current - 60Hz	Nominal running current		A	-		
Wiring connections - 50Hz	For power supply	Remark		3 for power supply, 4 for interunit wiring (Earth wire included)		

### Notes

(1) SL: The silent fan level of the air flow rate setting

(2) When connected with multi-system outdoor unit, refer to the specifications of the multi outdoor unit to be connected.

(3) 220V

(4) 230V

(5) 240V

### 3 Options

#### 3 - 1 Options

**FTXG25-50J**

	Description	Material name
Indoor	Wired remote controller	BRC944A2B
	5-room centralized controller	KRC72A
	Adopter PCB (normal open/normal open pulse contact)	KRP413AA1S
	Titanium apatite photocatalytic air-purifying filter without frame *	---
	Chain for preventing loss of remote controller	KKE910A
	Interface adapter for DIII-net use	KRP928BA2S
	Central remote controller	DCS302CA51
	Unified ON/OFF controller	DCS301BA51
	Schedule timer	DCT301BA51

\* Standard accessory

# 4 Dimensional drawings

## 4 - 1 Dimensional Drawings

4

### FTXG25-35J

- Note)  
 1. The mark (→) shows piping direction.  
 2. In this case, require the grille option.  
 3. In this case, cut the grille with paper pattern.

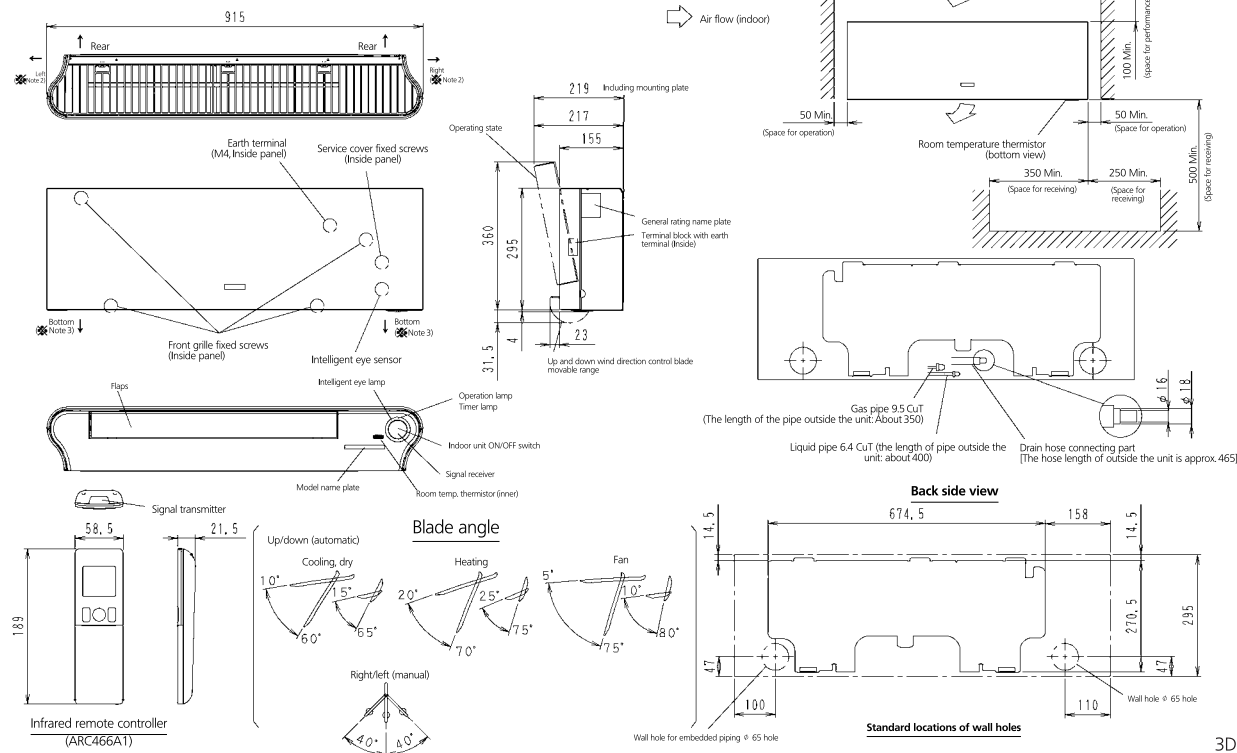

3D065841C

### FTXG50J

- Note)  
 1. The mark (→) shows piping direction.  
 2. In this case, require the grille option.  
 3. In this case, cut the grille with paper pattern.

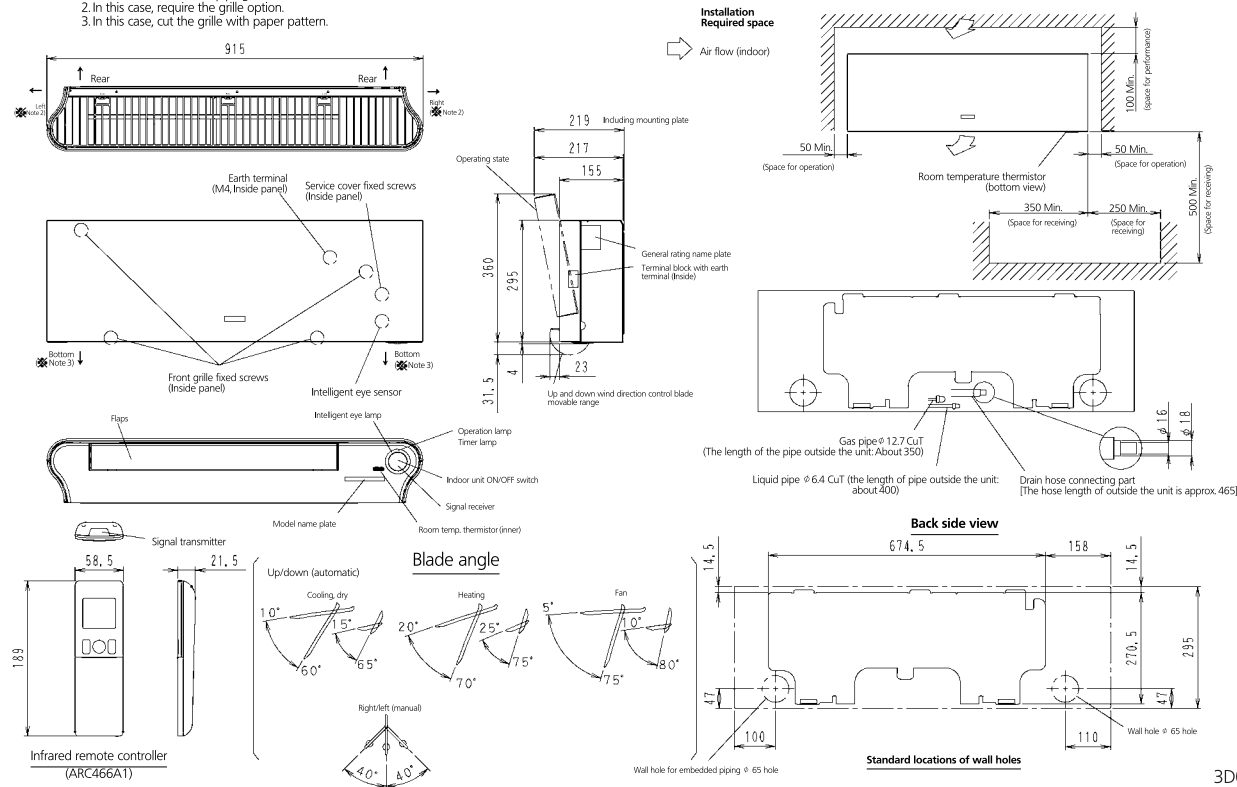

3D065842D

6

## 5 Centre of gravity

### 5 - 1 Centre of Gravity

FTXG25-50J

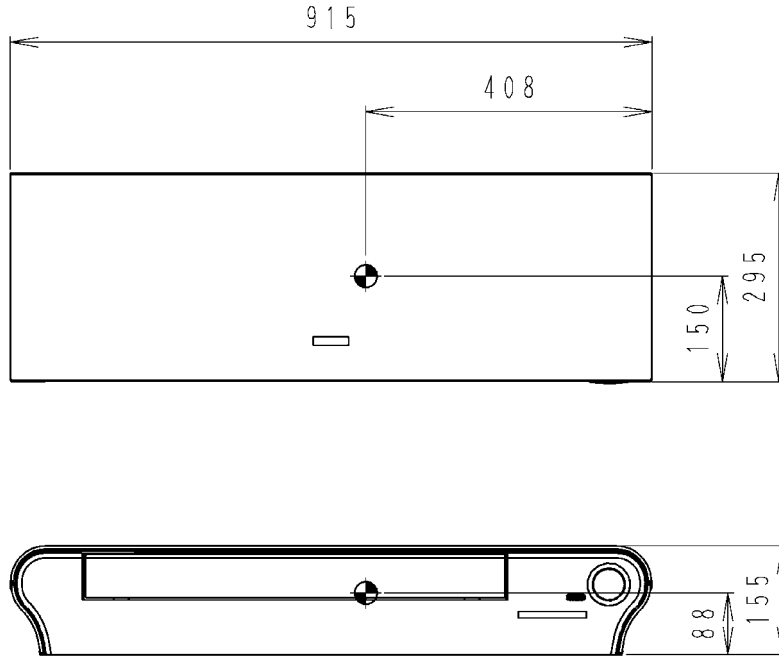

4D065844B



## 6 Piping diagrams

### 6 - 1 Piping Diagrams

6

FTXG25-35J

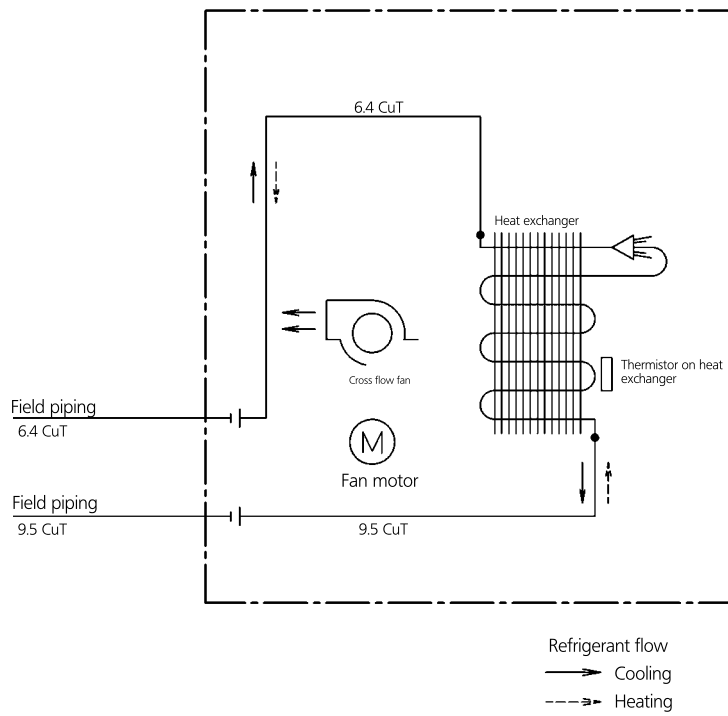

4D065855B

FTXG50J

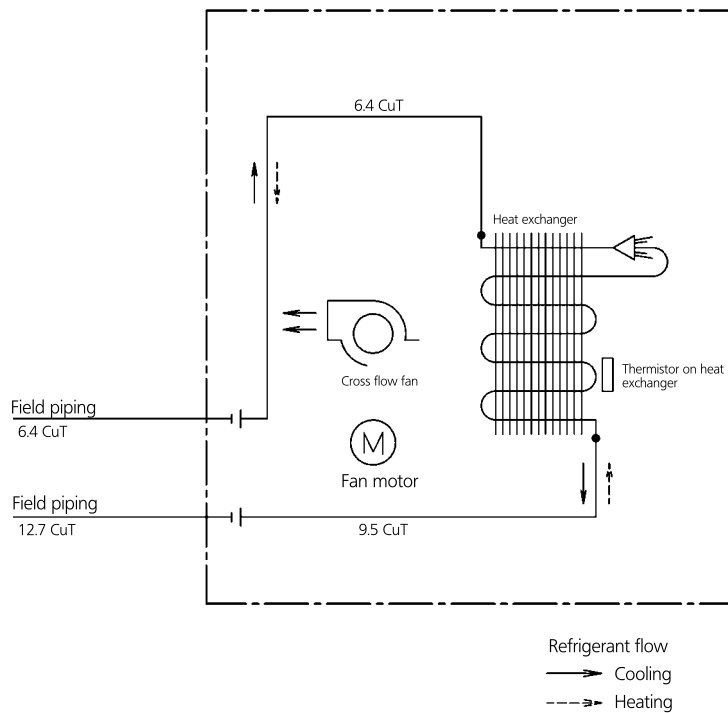

4D065856C

# 7 Wiring diagrams

## 7 - 1 Wiring Diagrams - Single Phase

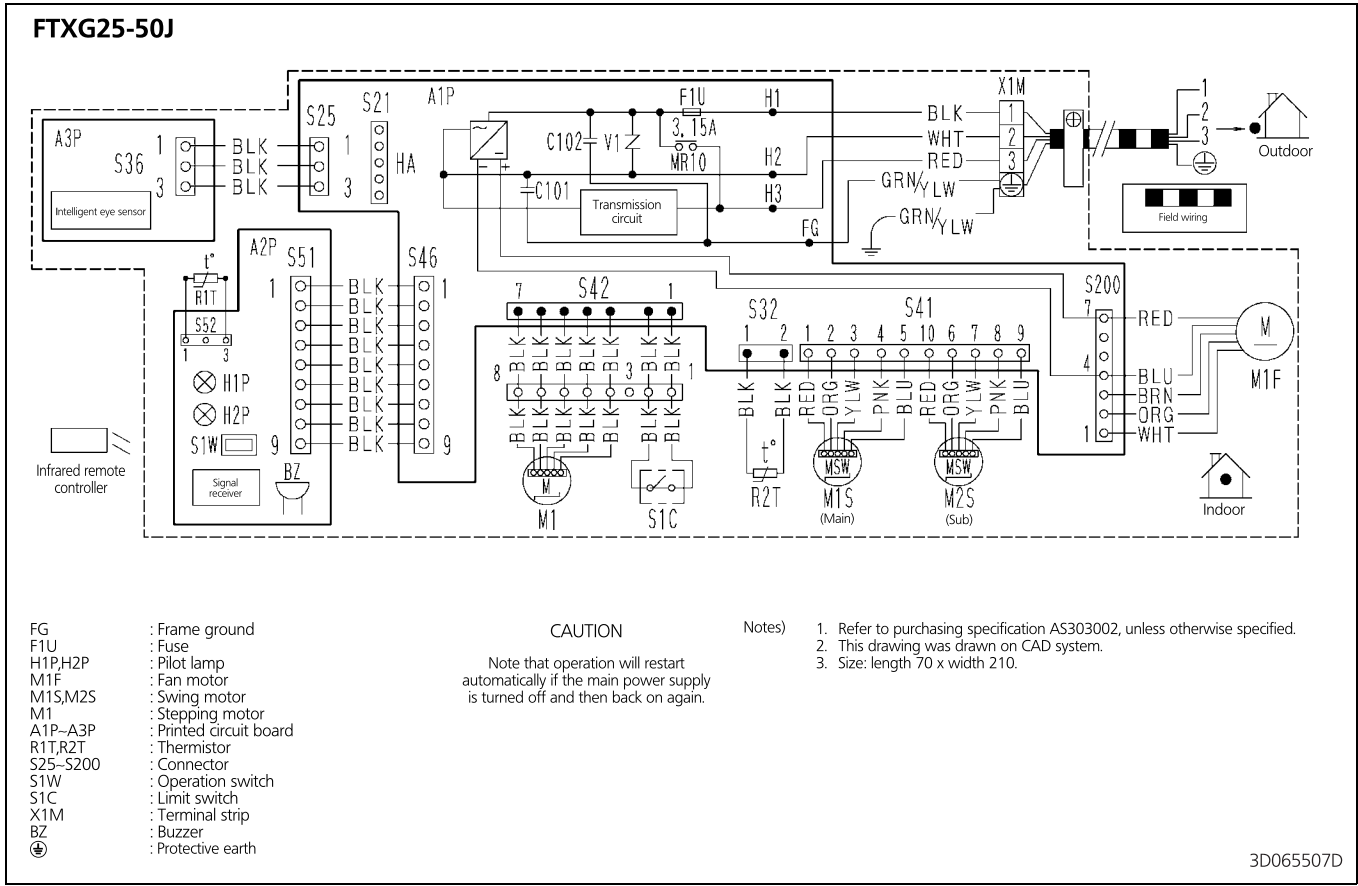

# 8 Sound data

## 8 - 1 Sound Pressure Spectrum

FTXG25J

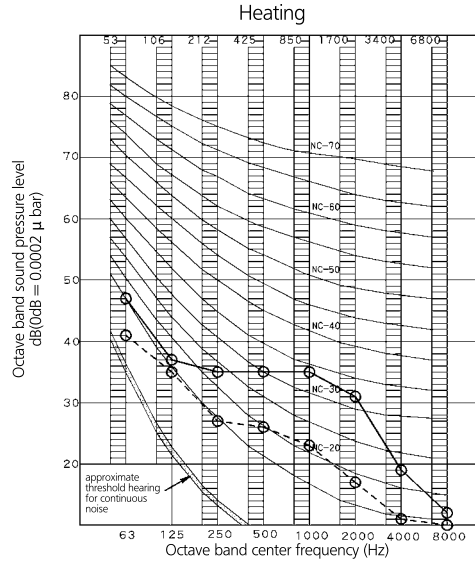
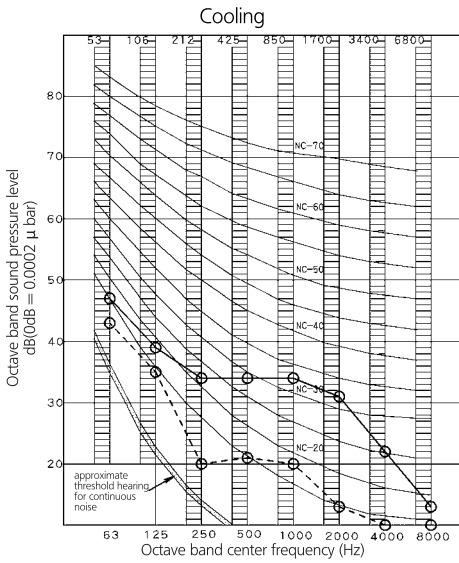

**NOTES**

- Overall (dB) (B,G,N is already rectified)
- Measuring place: Measure in anechoic room
- Operation noise differs with operation and ambient conditions.
- Operating conditions: Power source 220~240V 50Hz
- Location of microphone  
JISC9612  
The operation noise measuring method is in accordance with JISC9612
- Standard external static pressure  
○—○ 50 Hz 220-240V (H)  
○---○ 50 Hz 220-240V (L)

Scale	50Hz 220~240V (H)	50Hz 220~240V (L)
A	38	25

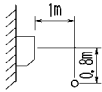

**NOTES**

- Overall (dB) (B,G,N is already rectified)
- Measuring place: Measure in anechoic room
- Operation noise differs with operation and ambient conditions.
- Operating conditions: Power source 220~240V 50Hz
- Location of microphone  
JISC9612  
The operation noise measuring method is in accordance with JISC9612
- Standard external static pressure  
○—○ 50 Hz 220-240V (H)  
○---○ 50 Hz 220-240V (L)

Scale	50Hz 220~240V (H)	50Hz 220~240V (L)
A	39	28

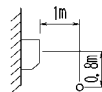

3D066708A

FTXG35J

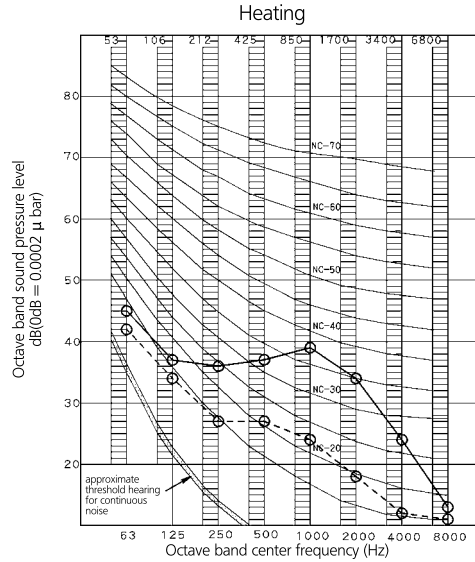
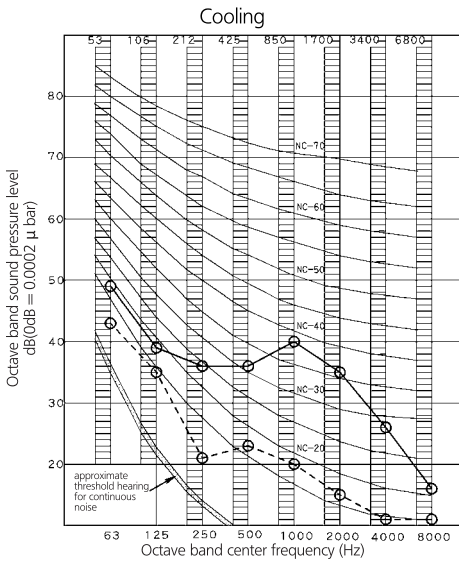

**NOTES**

- Overall (dB) (B,G,N is already rectified)
- Measuring place: Measure in anechoic room
- Operation noise differs with operation and ambient conditions.
- Operating conditions: Power source 220~240V 50Hz
- Location of microphone  
JISC9612  
The operation noise measuring method is in accordance with JISC9612
- Standard external static pressure  
○—○ 50 Hz 220-240V (H)  
○---○ 50 Hz 220-240V (L)

Scale	50Hz 220~240V (H)	50Hz 220~240V (L)
A	42	26

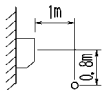

**NOTES**

- Overall (dB) (B,G,N is already rectified)
- Measuring place: Measure in anechoic room
- Operation noise differs with operation and ambient conditions.
- Operating conditions: Power source 220~240V 50Hz
- Location of microphone  
JISC9612  
The operation noise measuring method is in accordance with JISC9612
- Standard external static pressure  
○—○ 50 Hz 220-240V (H)  
○---○ 50 Hz 220-240V (L)

Scale	50Hz 220~240V (H)	50Hz 220~240V (L)
A	42	29

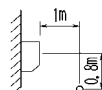

3D066709A

# 8 Sound data

## 8 - 1 Sound Pressure Spectrum

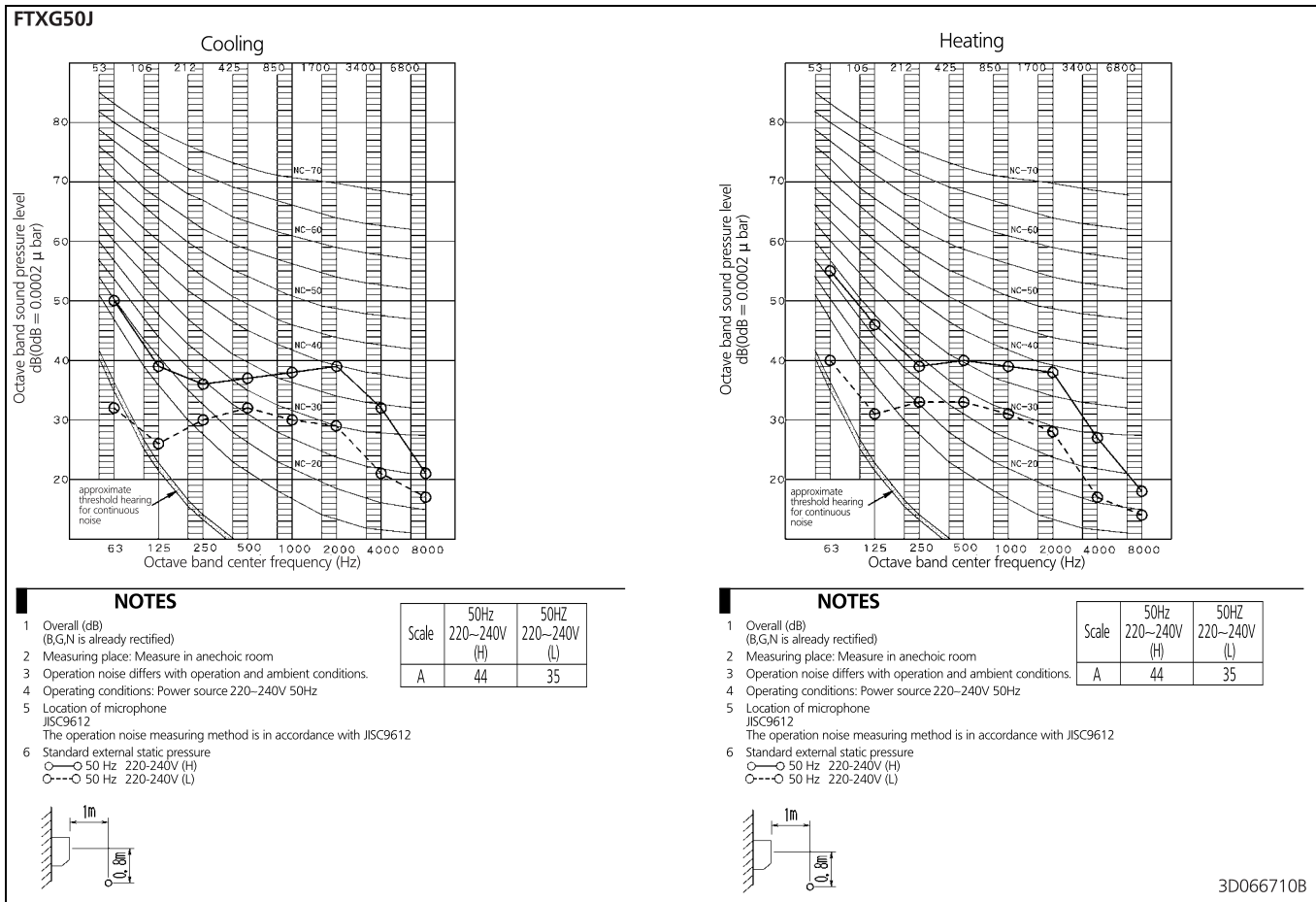

In all of us,  
a green heart



Daikin's unique position as a manufacturer of air conditioning equipment, compressors and refrigerants has led to its close involvement in environmental issues. For several years Daikin has had the intention to become a leader in the provision of products that have limited impact on the environment. This challenge demands the eco design and development of a wide range of products and an energy management system, resulting in energy conservation and a reduction of waste.

The present leaflet is drawn up by way of information only and does not constitute an offer binding upon Daikin Europe N.V. Daikin Europe N.V. has compiled the content of this leaflet to the best of its knowledge. No express or implied warranty is given for the completeness, accuracy, reliability or fitness for particular purpose of its content and the products and services presented therein. Specifications are subject to change without prior notice. Daikin Europe N.V. explicitly rejects any liability for any direct or indirect damage, in the broadest sense, arising from or related to the use and/or interpretation of this leaflet. All content is copyrighted by Daikin Europe N.V.



Daikin Europe N.V. participates in the Eurovent Certification programme for Air conditioners (AC), Liquid Chilling Packages (LCP), Air handling units (AHU) and Fan coil units (FCU). Check ongoing validity of certificate online: [www.eurovent-certification.com](http://www.eurovent-certification.com) or using: [www.certiflash.com](http://www.certiflash.com)



EEDEN12-100

Daikin products are distributed by: